

DCT Instruments

Product of Sensotec, Inc.

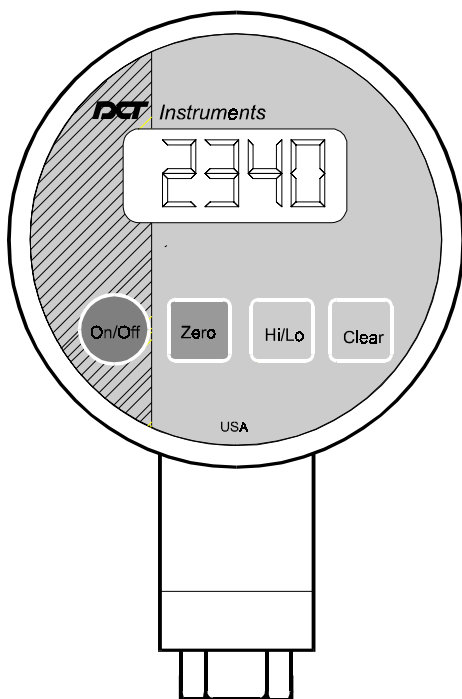

L Series

DIGITAL FORCE INDICATOR

DCT Instruments
products of Sensotec, Inc.
2080 Arlingate Lane
Columbus, Ohio 43228

TEL (614) 850-6020
FAX (614) 850-1144
1-800-328-1028

L Series Digital Force Indicator User's Guide
DCT Part Number: 77-01581-00
Rev. A: November, 2001
Copyright © 1999 by Sensotec, Inc.

IMPORTANT! IT IS RECOMMENDED THAT YOU READ THIS DOCUMENT THOROUGHLY BEFORE APPLYING POWER TO THIS UNIT. THIS DOCUMENT CONTAINS INFORMATION ON WIRING, CALIBRATION, AND USE OF FEATURES.

Chapter 1

INTRODUCTION

1.1	Overview	5
1.2	Instrument Layout	7
1.2.1	LCD Display	7
1.2.2	Low Battery Indicator	7
1.2.3	Decimal Point Position	8
1.2.4	Incremental Display Step	8
1.2.5	Load Sensor	8
1.3	Maximum Safe Overload	9
1.4	Front and Side Views	10
1.5	Dimensions	11
1.6	Specifications	12
1.7	Accessories	13

Chapter 2

OPERATION

2.1	Battery Replacement	15
2.2	Turning the Instrument On and Off	16
2.3	Zeroing the Display	16
2.4	Restoring the Calibrated Zero	17
2.5	Reading the High/Low Values	17
2.6	Clearing the High/Low Values	18

Chapter 3

FIELD SELECTABLE FEATURES

3.1	Introduction	19
3.2	Setup Menu Operation	19
3.3	Enable Options ("ED") Description	21
3.3.1	Auto-off Feature	21
3.3.2	Always-On Feature	22
3.3.3	<Zero> Button Disable Feature	22
3.3.4	<Hi/Lo> Button Disable Feature	22
3.3.5	<Clear> Button Disable Feature	22
3.4	Enable Options ("ED") Menu Item	23
3.5	Engineering Units ("UNIT") Menu Item	24
3.6	Auto-off time ("ROFF") Menu Item	26
3.7	Update Rate ("RATE") Menu Item	26
3.8	Internal Software Version ("VER") Menu Item	27

Chapter 4

CALIBRATION

4.1	Calibration Considerations	29
4.2	Required Forces	29
4.3	Calibration Procedure	31
4.3.1	Enter Forces to be Applied	31
4.3.2	Apply Forces	33
4.4	Rear View of Front Face Panel	35
4.5	Calibration Error Messages	36

Chapter 5

TROUBLESHOOTING

5.1	Introduction	37
5.2	Help Message Codes	37
5.3	Troubleshooting Hints	38

Chapter 6

WARRANTY/REPAIR POLICY

6.1	Limitation of Remedy and Disclaimer of Warranty . 39	
6.2	Obtaining Service Under Warranty	40
6.3	Obtaining Non-warranty Service	40
6.4	Repair Warranty	40

Chapter 1

INTRODUCTION

1.1 Overview

The “Series L” Digital Force Indicator is a highly portable force measurement device. With its 9V battery supply and compact size, the indicator can easily be carried to remote locations to perform force measurement calibrations. Depending on the model, the instrument can measure forces in compression only or both in tension and compression. Ranges are available up to 50,000 lbs.

The peak capture feature allows the highest force reading taken to be displayed with the push of a button. A zero/tare button is also standard on all models.

The remote location of the load sensor minimizes the change of damage to the electronic body of the instrument. The sensor and the indicator are constructed of stainless steel.

An easy-to-read digital display provides 4½ digits. The waterproof membrane face uses raised buttons with tactile feedback for ease of setup and operation. Zero adjustment, zero offset/tare, high, low and clear functions are standard on each instrument. Calibration and setup information are stored in non-volatile memory to protect from loss even when power is interrupted. Unauthorized calibrations are also blocked with internal security.

Other feature include:

- Several sensor configurations available
- Adjustable update rate

-
- User-selectable units of measure
 - User-selectable automatic shut-off interval
 - 4½ digit display

1.2 Instrument Layout

1.2.1 LCD Display

The 4½-digit liquid crystal display (LCD) readout displays the force applied to the instrument, interacts with the user when the instrument is being set up or calibrated, and indicates if there is a problem with the instrument.

When a “Series L” instrument is turned on, it illuminates all LCD segments. Then, the engineering units the gauge will be using appears on the display. Most “Series L” instruments are calibrated in pounds (“*LBS*”) and the instrument has conversion factors for many standard engineering units built in. However, if the instrument displays *SPCL* (special) it has been specially calibrated to another engineering unit at the factory. In that case, the serial number tag on the top of the instrument will indicate the engineering units being used and the capability to select other engineering units should not be used.

After the display of the engineering units, the force applied to the load sensor is shown on the display. If the force applied to the load sensor is above the instrument's ability to measure, the display will indicate this overrange condition by showing a “*r*” on the far left hand side of the display. The display will read “*-r*” if the instrument is underranged.

1.2.2 Low Battery Indicator

On the left side of the display, just above the minus sign, is the low battery indicator (in the shape of an arrow). When the battery voltage is less than 5 volts, the display will be blanked and the low battery indicator will illuminate to indicate that the batteries should be replaced. The low battery indicator can be seen when the instrument is turned on and all segments of the display are momentarily lighted.

When the low battery indicator is illuminated, change the batteries as soon as possible. The instrument will not function if the battery voltage falls below approximately 4 volts.

1.2.3 Decimal Point Position

The decimal point position automatically changes depending upon:

- the user selected engineering units
- the force range of the instrument

The decimal point position cannot be changed manually.

1.2.4 Incremental Display Step

The incremental display step is the value which the last digit of the display will change by. This value will either be 1, 2, or 5 display counts. It automatically changes depending upon:

- the user selected engineering units
- the force range of the instrument

The incremental display step cannot be changed manually.

1.2.5 Load Sensor

The “Series L” instrument can be ordered with several different types of load sensors depending on the desired range and ability to measure forces in compression only or in tension/compression.

1.3 Maximum Safe Overload

Maximum safe overload is the force which the load sensor can experience occasionally without loss of accuracy or permanent damage. The maximum safe overload is 150% of the full-scale range of the instrument.

1.4 Front and Side Views

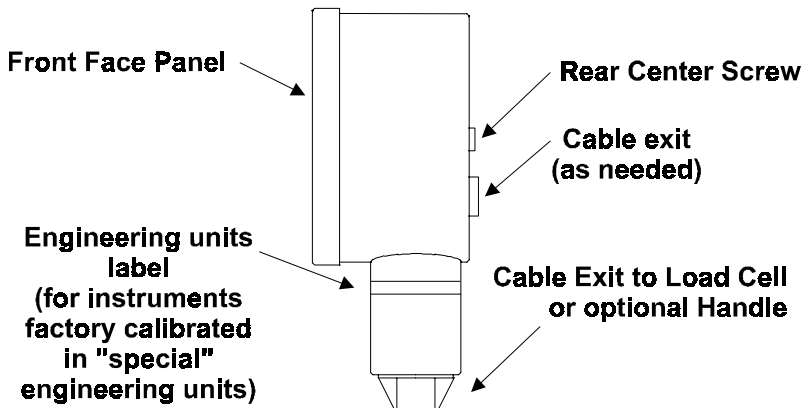

Figure 1-1: "Series L" Display Side View

1.5 Dimensions

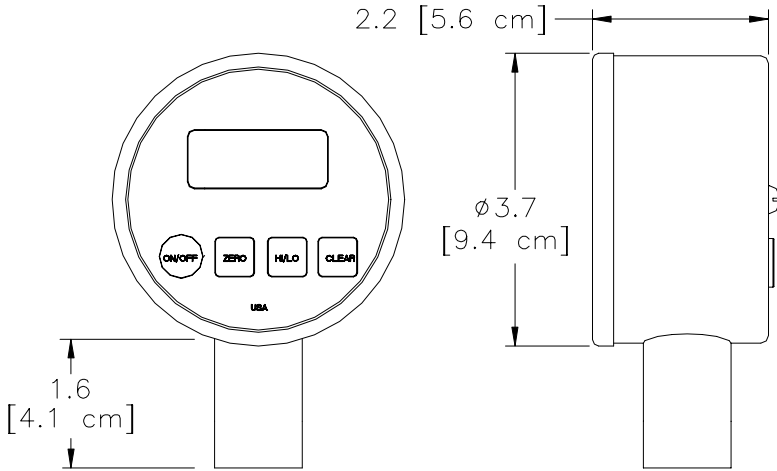

Figure 1-2: "Series L" Display Dimensions

1.6 Specifications

DCT Instruments continually improves its products, and thus these specifications are subject to change without notice.

Rating:	NEMA 2
Diameter:	3.7 inches
Linearity and Hysteresis:	.2% of full-scale
Operating Temperature:	30 to 160 °F
Overload Capacity:	150% of full-scale range
Calibration Engineering Units:	lbs
Built-in Engineering Unit Conversion:	lbs, Kg, kN, N, g (field selectable)
Special Engineering Units:	Optional
Display:	4½ digit LCD digits, 0.5 inches high
Display Update Rate:	2 to 10 per second (field selectable) (factory default 3 per second)
Power Requirements:	Two 9 Volt alkaline batteries provide approximately 80 hrs continuous operation
Load Sensor Material:	Stainless steel
Housing Material:	Stainless steel
High and Low Capture:	Standard, same update rate as display
Zero and Span Adjustment:	Standard
Front Panel Membrane	Tactile feedback, raised buttons
Calibration Data:	Stored on non-volatile memory chip

1.7 Accessories

<u>Accessory</u>	<u>DCT Order Code</u>
PANEL MOUNTING RING (to facilitate panel mounting)	MR2
CARRYING CASE	CC5
NIST CERTIFICATION	NISTCERTS

Chapter 2

OPERATION

2.1 Battery Replacement

Two nine volt alkaline batteries (NEDA 1604) are recommended for use in “Series L” instruments. This is a common type of battery which is available at many stores. With two alkaline batteries, a “Series L” instrument will operate continuously on for approximately 80 hours. Carbon-zinc batteries (sometimes labeled as “general purpose” or “heavy duty”) should not be used. Please note that the temperature specifications of the batteries you purchase may not be the same as those of the instrument.

If two batteries are not available, the instrument will operate with only one alkaline battery installed in either clip. However, this will reduce the continuous operation time to approximately 40 hours.

The use of two lithium batteries will allow your “Series L” instrument to operate continuously for over 160 hours.

To install the batteries:

- 1) Remove the center screw on the back of the instrument.
- 2) Remove the front face panel from the case.
- 3) The colored ribbon cable extending from the sensor to the electronics may be disconnected to make the battery installation more convenient.
- 4) Replace the batteries one at a time, making sure of the

correct polarity.

5) Reconnect the sensor cable to the electronics.



Important note: The brown wire of the sensor cable must be on the right as you face the circuit board, as shown on Figure 3-1. If you connect the sensor cable backwards, the instrument will not operate correctly.

6) Replace the front face panel.

7) Carefully replace the rear center screw.

Note: Calibration and setup values are stored in a nonvolatile memory, and are not lost during battery replacement.

2.2 Turning the Instrument On and Off



Push the <On/Off> button to turn the instrument on or off.

As the instrument turns on, every segment on the display is momentarily lighted. The high/low data values are cleared.

2.3 Zeroing the Display



Hold the <Zero> button until the the display shows “-0-” (about 5 seconds).

The instrument will retain this zero value even after the instrument has been turned off.

2.4 Restoring the Calibrated Zero

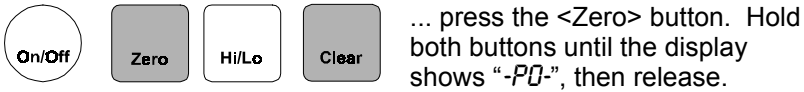
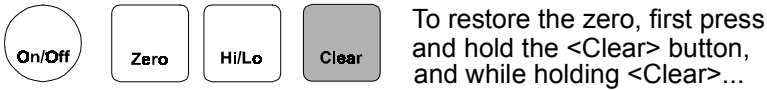

The "calibrated zero" is the zero value of the instrument at the time it was last calibrated. Restoring the calibrated zero can be used to “undo” an inadvertent press of the <Zero> button.

2.5 Reading the High/Low Values

The high and low values are updated at the same rate as the tracking value.

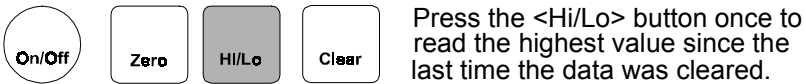

The word "HI" and the corresponding value will flash intermittently on the display. This flashing indicates that the instrument is not displaying the "live" tracking value of the process pressure. However, the instrument is still monitoring the process pressure and updating the high and low values.

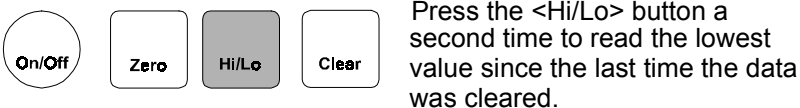

The word "LO" and the corresponding value will flash intermittently on the display. This flashing indicates that the instrument is not displaying the "live" tracking value of the process pressure. However, the instrument is still monitoring the process pressure and updating the high and low values.



Press the <Hi/Lo> button a third time to return to the “live” tracking mode. The display will show “--” to indicate that the instrument has returned to the “live” tracking mode.

2.6 Clearing the High/Low Values



Press the <Clear> button to erase the high and low data values.

The high and low data values are also cleared when the instrument is turned off.

Chapter 3

FIELD SELECTABLE FEATURES

3.1 Introduction

This Chapter discusses the field selectable features available on the “Series L” Digital Force Indicator. These features can be activated, deactivated and modified via the Setup Menu accessed by the front panel.

These field selectable features include:

- Enabling the automatic power off feature to conserve battery life
- Disabling the front panel buttons
- Changing the engineering units used to display the applied force
- Adjusting the automatic power off time
- Changing the update rate

3.2 Setup Menu Operation

All of the field selectable features are accessed via the Setup Menu. This section discusses its operation.

To change a feature with the Setup Menu:



Make sure the instrument is turned off. Then, press the <On/Off> button



While unit is checking the display (lighting all LCD segments simultaneously) press and hold down the <Zero> button.

The display now reads “*L-L0*”, which is the first item of the Setup Menu. Release the <Zero> button.



Pressing and releasing the <Zero> button will scroll down through the available Setup Menu items.

The table below provides a list of the items available in the Setup Menu and a brief description of each.

Table 1: Setup Menu Items

Display	Menu Item	Purpose
<i>L-L0</i>	Low Limit setpoint	N/A
<i>L-HI</i>	High Limit setpoint	N/A
<i>EO</i>	Enable Options	Enable Auto-Off feature; Disable front panel buttons
<i>UNIT</i>	Engineering units	Change engineering units used to display pressure
<i>ROFF</i>	Auto-off time	Change Auto-Off power down time
<i>RATE</i>	Update rate	Change update rate of pressure readings
<i>VER</i>	Internal software revision	Display internal software part number and revision

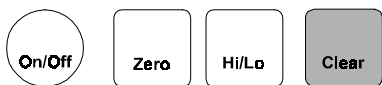

When the menu item you wish to change is displayed, press <Clear>.

The display now shows the present setting of that menu item. If you only wish to examine the present setting of the menu item, you can use the <On/Off> button to turn the instrument off. Otherwise...

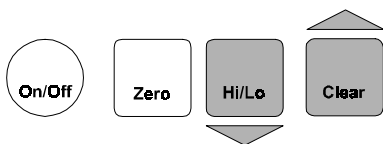

Use the <Hi/Lo> and <Clear> buttons to scroll up and down, respectively.

If you wish to abandon the changes you made to this setting, you can use the <On/Off> button to turn the instrument off. Otherwise...



Once the setting you want is displayed, press the <Zero> button to store this setting into memory.

The next menu item will be displayed after the instrument stores the setting into memory.

3.3 Enable Options (“*EO*”) Description

The Enable Options (“*EO*”) menu item controls the features described in the sub-sections below.

3.3.1 Auto-off Feature

The unit will shut itself off if no buttons are pressed for the time duration specified with the Auto-off time (“*ROFF*”) menu item. The unit can also be shut off with the <On/Off> button.

This feature is useful for conserving battery life.

3.3.2 Always-On Feature

The <On/Off> button is disabled and will not shut the unit off. This mode is used so that the high and low capture values, output signals, or limit alarms are not interrupted if an operator tries to shut the unit off during testing or monitoring.



3.3.3 <Zero> Button Disable Feature

This feature disables the ability to zero the display of the instrument. The ability to restore the calibrated zero is also disabled. When the ZERO button is pressed, the display momentarily reads “-ED-” which indicates that the button has been disabled via the Enable Options menu item.



3.3.4 <Hi/Lo> Button Disable Feature

This feature disables the ability to read the stored high and low values on the display. The display will always read the “live” tracking value of the process pressure. When the <Hi/Lo> button is pressed, the display will momentarily read “-ED-” which indicates that the button has been disabled via the Enable Options menu item.

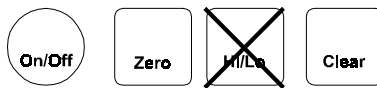

3.3.5 <Clear> Button Disable Feature

This feature disables the ability to clear the high and low data values with the <Clear> button. The ability to restore the calibrated zero is also disabled. When the <Clear> button is pressed, the display momentarily reads “-ED-” which indicates that the button has been disabled via the

Enable Options menu item. **NOTE:** The high and low data values may also be cleared by turning the unit off and back on, unless the Always-on feature is used.

3.4 Enable Options (“ED”) Menu Item

To activate or deactivate the features described in the previous section, the setting of the Enable Options (“ED”) menu item must be changed. The procedure to change the setting of a menu item is described in the “Setup Menu Operation” section earlier in this Chapter.

The setting value of the Enable Options (“ED”) menu item is obtained by adding together the values of the desired options according to the table below.

Table 2: Enable Options (“ED”) settings

Feature	Disabled	Enabled
Auto-off	0	1
Always-on	0	2
<Zero> button	4	0
<Clear> button	16	0
<Hi/Lo> button	32	0

For example, to enable the Auto-off feature and disable the <Zero> button enter a setting value of “0005”. As another example, to disable both the <Zero> and the <Clear> buttons enter a setting value of “0020”.

If the Auto-off and Always-on features are both activated, the unit will behave as follows: The <On/Off> button can turn the instrument on but it cannot turn the instrument off. The only way to turn the instrument off is not to press any buttons for the duration specified in the Auto-off time (“ROFF”) menu item. Note that the Auto-off time (“ROFF”)

setting can be several hours.

3.5 Engineering Units (“UNIT”) Menu Item

The Engineering Units (“UNIT”) menu item determines which units-of-measure are used to display the pressure readings. “Series L” instruments are calibrated in lbs and the instrument has conversion factors for many standard engineering units built in. The procedure to change the setting of a menu item is described in the “Setup Menu Operation” section earlier in this Chapter.



Important note: If the instrument displays *SPCL* (special) when powering up, it has been specially calibrated to another engineering unit. **Do not** change the engineering units to anything other than *SPCL* or the instrument will not operate properly.

The table below gives a list of the engineering units built into the instrument.

Table 3: Engineering Units (“UNIT”) Available Settings

Setting	Engineering Unit / Comment
<i>RDC</i>	for factory use only
<i>SPCL</i>	Special calibration. Serial number tag will indicate engineering units being used.
<i>LBS</i>	lbs
<i>N</i>	N
<i>KN</i>	kN
<i>G</i>	g
<i>KG</i>	kg

3.6 Auto-off time (“*ROFF*”) Menu Item

The Auto-off time (“*ROFF*”) menu item is only meaningful if the Auto-off feature is enabled in the Enable Options (“*EO*”) menu item. The procedure to change the setting of a menu item is described in the “Setup Menu Operation” section earlier in this Chapter.

The table below gives a list of the available settings for the Auto-off time (“*ROFF*”).

Table 4: Auto-off time (“*ROFF*”) Available Settings

Setting	Time
0	4 minutes
1	1 hour
2	2 hours
3	3 hours
4	4 hours
5	5 hours
6	6 hours
7	7 hours
8	8 hours

3.7 Update Rate (“*RATE*”) Menu Item

The Update Rate (“*RATE*”) menu item determines the number of times the pressure readings are updated per second. The track, high and low values are all updated at this rate. The update rate can be varied from 2 to 10 updates per second. As shipped from the factory, the update rate is set to 3 per second.

3.8 Internal Software Version (“*VER*”) Menu Item

The Internal Software Version (“*VER*”) menu item displays the part number and version number of instrument’s operating software. The software part number and version number are of the form:

084-1087-00 1.19

Where the “084-1087-00” is the part number, and the “1.19” is the version number.

Since this string is too long to fit on the 4½ digit-display, pressing either the <Hi/Lo> or <Clear> buttons will scroll through this string 4 characters at a time.

Chapter 4

CALIBRATION

4.1 Calibration Considerations

In order to obtain optimum performance from an “Series L” instrument when testing or re-calibrating, DCT Instruments recommends the following:

- Allow a 5-minute warm-up period before testing or calibration.
- The pressure standard you use should be at least 4 times more accurate than the specification of the “Series L” instrument.

4.2 Required Forces

In order to re-calibrate the instrument, you must have a precision force standard that can produce the zero-scale, half-scale and full-scale forces for the instrument's range. Examine the table below to determine the three forces needed to calibrate your instrument. For example, if your “Series L” instrument has a range of 500 lbs, your force standard must be able to accurately produce forces of 0 lbs, 250 lbs and 500 lbs.

If your force standard cannot produce these exact values, the instrument can be programmed in the field to expect slightly different values during the re-calibration process. For example, if your calibrated weights are equal to 0 lbs, 251 lbs and 498 lbs, you can program the instrument to expect these weights during the re-calibration process.

All “Series L” instruments are calibrated in PSI regardless of the field-selected engineering units. However, if the instrument displays the word “*SPECIAL*” (special) when it pow-

ers up, it has been specially calibrated to another engineering unit. In that case, the serial number tag on the top of the instrument will indicate the engineering units that will be used for re-calibration.

To maintain NIST traceability, DCT Instruments can re-calibrate a “Series L” instrument for you. NIST certificates may be ordered as a separate accessory for a nominal fee.

4.3 Calibration Procedure

The calibration procedure consists of two parts, the first of which may not be necessary in all applications.

- First, the instrument is told exactly what zero-scale, half-scale and full-scale forces are to be applied during the calibration procedure.
- Second, the forces are applied to the instrument.

The following two sections explain this procedure.

4.3.1 Enter Forces to be Applied

The expected force values to be applied during calibration are accessed via the Factory Configuration Menu. This section discusses its operation.

To change a value with the Factory Configuration Menu:

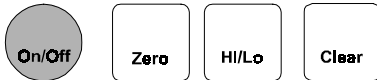

Make certain the instrument is turned off.

Open up the instrument by removing the center screw on the back. Next, remove the front face panel. Take care not to break the wires extending from the sensor to the electronics. As indicated on Figure 4-1, move the mode jumper from the "**park**" position to the "**configure**" position.



Hold the <On/Off> button, then press the <Hi/Lo> button. The display will momentarily read "**DP-2**".

Release the <Hi/Lo> button, and the display will read "**DP**" which is the first item of the Factory Configuration Menu.



Pressing and releasing the <Zero> button will scroll down through the available Factory Configuration Menu items.

The table below provides a list of the items available in the Factory Configuration Menu and a brief description of each.

Table 5: Factory Configuration Menu Items

Display	Menu Item	Purpose
<i>DP</i>	Decimal Point	How many decimal points are used to edit the “P0”, “P1” and “P2” Factory Configuration Menu items.
<i>P0</i>	Zero-Scale Point	The expected value in lbs of the force to be applied at zero scale.
<i>P1</i>	Half-Scale Point	The expected value in lbs of the force to be applied at half scale.
<i>P2</i>	Full-Scale Point	The expected value in lbs of the force to be applied at full scale.
<i>INP</i>	Input Range	For factory use only. Do not change this setting.
<i>TYPE</i>	Engineering Units Type	Must be set to “000” for force units. Do not change this setting.



When the menu item you wish to change is displayed, press <Clear>.

The display now shows the present setting of that menu item. If you only wish to examine the present setting of the menu item, you can use the <On/Off> button to turn the instrument off. Otherwise...

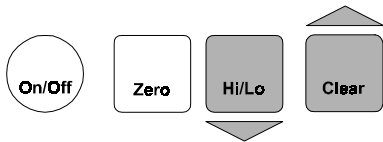

Use the <Hi/Lo> and <Clear> buttons to scroll up and down, respectively.

If you wish to abandon the changes you made to this setting, you can use the <On/Off> button to turn the instrument off. Otherwise...



Once the setting you want is displayed, press the <Zero> button to store this setting into memory.

The next menu item will be displayed after the instrument stores the setting into memory.

After you have finished using the Factory Configuration Menu, the mode jumper must be moved from its "**configure**" position to its "**park**" position as indicated in Figure 4-1. Close the unit up and replace the center screw.

4.3.2 Apply Forces

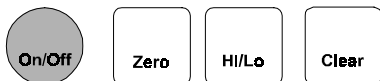

Make certain the instrument is turned off.

Open up the instrument by removing the center screw on the back. Next, remove the front face panel. Take care not to break the wires extending from the sensor to the electronics. As indicated on Figure 4-1, move the mode jumper from the "**park**" position to the "**calibration**" position.

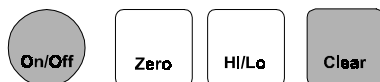

Hold the <On/Off> button, then press the <Clear> button. The display will momentarily read "0P.7".

The display will begin to alternately flash between the force required for calibration point #0 (for example "000.0")

and "----"). If you wish to abandon the calibration procedure, press the <On/Off> button to turn the unit off. Otherwise...



Apply the indicated force to the instrument. Press <Clear> until "-P-" is displayed, indicating that the reading is being stored.

Next, the display will begin to alternately flash between the force required for calibration point #1 (for example, "050.0") and "----".



Apply the indicated force to the instrument. Press <Clear> until "-P-" is displayed, indicating that the reading is being stored.

Finally, the display will begin to alternately flash between the force required for calibration point #2 (for example, "100.0" and "----").



Apply the indicated force to the instrument. Press <Clear> until "-P-" is displayed, indicating that the reading is being stored.

When the last force point has been entered, the instrument will turn itself off. At this time, the mode jumper must be moved from its "calibration" position to its "park" position as indicated in Figure 4-1. Close the unit up and replace the center screw.

Check that the instrument has been calibrated properly by turning it back on and using the force standard.

4.4 Rear View of Front Face Panel

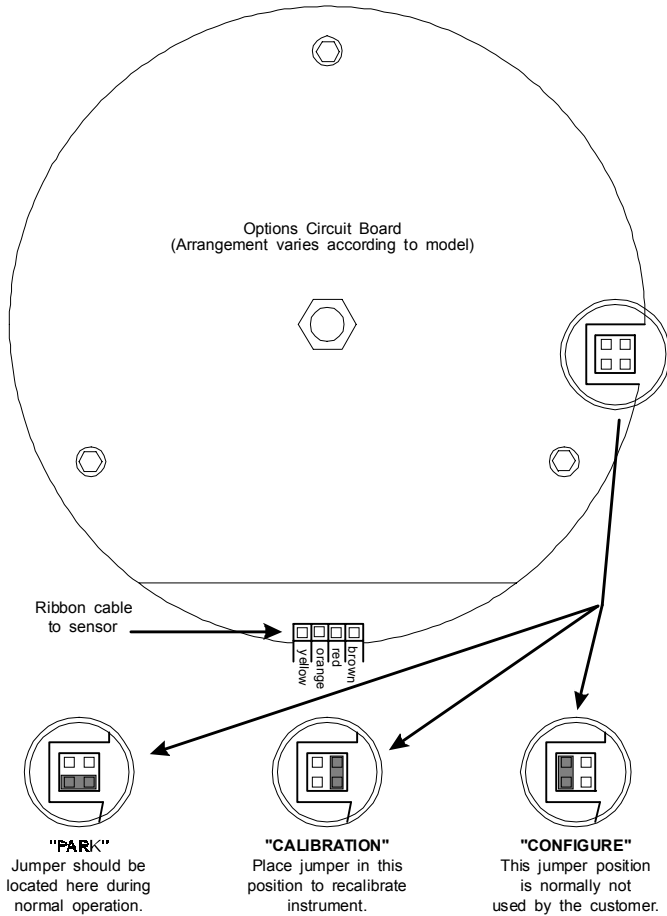

Figure 4-1: Front face panel (rear view), showing mode jumper positions and orientation of sensor cable

4.5 Calibration Error Messages

If unexpected pressures are encountered during the calibration procedure, the “Series L” instrument will alert the user by flashing the word “*HELP*” and a message number on the display. This indicates that the calibration process cannot continue, and that you must turn the instrument off and re-calibrate again when the error has been corrected. A list of error message numbers and their causes is given in Chapter 5, “Troubleshooting”.

Chapter 5

TROUBLESHOOTING

5.1 Introduction

This chapter provides information on correcting common problems that may be encountered operating and calibrating the instrument.

5.2 Help Message Codes

If the instrument detects a problem during its power-on self-test, operation, or calibration, it will alert the user by flashing the word “*HELP*” and an error message code number on the display. The instrument cannot continue operation and you must turn the instrument off and correct the error.

- “*HELP 01*”: Calibration error.
Analog to digital converter overrange.
One of the applied force points is above the calibration range of the instrument. Or, the sensor cable is not connected properly.
- “*HELP 02*”: Calibration error.
Analog to digital converter underrange.
One of the applied force points is below the calibration range of the instrument. Or, the sensor cable is not connected properly.
- “*HELP 04*”: Calibration error.
The applied forces at any two calibration points did not differ enough.
- “*HELP 23*”: Self-test error.
The engineering unit conversion that you selected cannot be rendered on a 4½-digit display. For example, consider the case of an instrument with a range of

2000 lbs. If you were to select grams (“G”) in the Engineering Units (“UNIT”) menu item the instrument would signal this error. This is because 2000 lbs equals 907184 grams which cannot be shown on a 4½-digit display.

- “HELP 27”: Non-volatile memory write error.
“HELP 28”: Non-volatile memory read error.
“HELP 29”: Non-volatile memory verify error.
“HELP 39”: Non-volatile memory version mismatch.
“HELP 40”: Analog-to-digital converter not ready.
Turn the instrument off and on again. If these problems persist, contact DCT Instruments.

5.3 Troubleshooting Hints

- Verify that the power source is operating correctly. Make sure the batteries are fresh or that the external supply is wired correctly.
- Verify that the sensor cable is connected correctly. Chapter 4, Figure 4-1 shows the correct orientation of the sensor cable.
- If you have changed the display update rate from the factory default of 3 per second, it may now be set too high for your application and this may be interpreted as the readings being “shaky”. Try reducing the display update rate.
- The sensor and the electronics are a matched set. Do not, under any circumstances, exchange sensor and electronics on two different instruments.
- The <Zero> button must be held down for 5 seconds before the display will be zeroed. This is in order to prevent unintentional zeroing of the display.
- If the instrument displays “PSI” or another pressure unit of measure, change the “TYPE” register back to “0001”.

Chapter 6

WARRANTY/REPAIR POLICY

6.1 Limitation of Remedy and Disclaimer of Warranty

Any of our products which, under normal operating conditions, proves defective in material in workmanship within eighteen (18) months from the date of shipment by DCT Instruments/Sensotec, Inc., will be repaired or replaced free of charge, provided that the buyer (1) promptly notifies DCT Instruments/Sensotec, Inc. of any such defect; (2) provides DCT Instruments/Sensotec, Inc. with satisfactory proof of the defect and that the product was properly installed, maintained, and operated within the limits of rated and normal usage; and (3) obtains from DCT Instruments/Sensotec, Inc. authorization to return the product. Any such product shall be returned with transportation charges prepaid. The replacement product will be shipped F.O.B. our plant.

The remedy set forth herein does not extend to any product or part thereof which, under normal usage, has an inherently shorter useful life than one year. The remedy set forth herein does not apply to damage or to defects in any product caused by the buyer's misuse or neglect, nor does it apply to any product which has been repaired or disassembled which, in the sole judgement of DCT Instruments/Sensotec, Inc. affects the performance of the product.

The remedy set forth herein is the buyer's exclusive remedy, and will satisfy all obligations of DCT Instruments/Sensotec, Inc. whether based on contract, negligence, or otherwise. DCT Instruments/Sensotec, Inc. is not responsible for any incidental or consequential loss or damage which might result from a failure of any DCT Instruments/Sensotec, Inc. product.

THIS EXPRESS WARRANTY IS MADE IN LIEU OF ANY AND ALL OTHER WARRANTIES, EXPRESS OR IMPLIED, INCLUDING IMPLIED WARRANTY OF MERCHANTABILITY OR FITNESS FOR PARTICULAR PURPOSE.

6.2 Obtaining Service Under Warranty

Advanced authorization is required prior to the return to DCT Instruments/Sensotec, Inc. Before returning the items, either write to the Repair Department c/o DCT Instruments/Sensotec, Inc., 2080 Arlinggate Lane, Columbus, Ohio 43228, or call (800) 328-1028 with: 1) a model number; 2) a serial number of the defective product; 3) a technical description* of the defect; 4) a no-charge purchase order number (so products can be returned to you correctly); and 5) ship and bill addresses. Shipment to DCT Instruments/Sensotec, Inc. shall be at Buyer's expense and repaired or replacement items will be shipped F.O.B. our plant in Columbus, Ohio. Non-verified problems or defects may be subject to an evaluation charge. Please return the original calibration data with the unit.

6.3 Obtaining Non-warranty Service

Advance authorization is required prior to the return to DCT Instruments/Sensotec, Inc. Before returning the item, either write to the Repair Department c/o DCT Instruments/Sensotec, Inc., 2080 Arlinggate Lane, Columbus, Ohio 43228, or call (800) 328-1028 with: 1) a model number; 2) a serial number of the defective product; 3) a technical description* of the malfunction; 4) a purchase order number to cover DCT Instruments/Sensotec, Inc.'s repair cost; and 5) ship and bill addresses. After the product is evaluated by DCT Instruments/Sensotec, Inc., we will contact you to provide the estimated repair costs before proceeding. The minimum evaluation charge is \$95. Shipment to DCT Instruments/Sensotec, Inc. shall be at Buyer's expense and repaired items will be shipped to you F.O.B., our plant in Columbus, Ohio. Please return the original calibration data with the unit.

6.4 Repair Warranty

All repairs of DCT Instruments/Sensotec, Inc. products are warranted for a period of 90 days from date of shipment. This warranty applies only to those items which were found defective and repaired. It does not apply to products in which no defect was found and returned as is or merely recalibrated. Out of warranty products may not be capable of being returned to the exact original specifications or dimensions.

** Technical description of the defect: In order to properly repair a product, it is necessary for DCT Instruments/Sensotec, Inc. to receive information specifying the reason the product is being returned. Specific test data, written observations on the failure and specific corrective action you require is needed.*